

OPERATION AND MAINTENANCE BOOK

OPTISAN

















PREAMBLE

This manual must be considered as an integral part of the machine, and it must always be available for the people interacting with the machine itself; the manual must always accompany the machine, even if it is transferred to another user.

The operators must read this manual and carefully follow the instructions given therein, as **ESCOWA AB** shall not be held responsible for damage caused to people and/or property, or suffered by the machine itself, if the following conditions are not complied with. The Customer is required to keep trade secrets, therefore these documents and attachments must not be tampered with or modified, reproduced or transferred to third parties without the permission of **ESCOWA AB**.

SYMBOLS AND SIGNS

The manual, and/or in some cases the machine, feature: plates, symbols or icons that indicate an obligation, a danger or a prohibition.

OBLIGATION SIGNS	
<ul style="list-style-type: none"> Obligation to consult the document, which must be available for future use and must not be deteriorated in any way. 	 
<ul style="list-style-type: none"> Operations that require the use of specialised and authorized personnel. 	
<ul style="list-style-type: none"> Obligation to wear personal protective equipment (PPE) made available to the employer (e.g. leather gloves) when performing certain tasks. 	
<ul style="list-style-type: none"> Obligation to turn off the machine before carrying out any installation, cleaning, topping up, maintenance operation, etc.; remove the plug. 	
<ul style="list-style-type: none"> Obligation to dispose of electrical and electronic waste. 	
DANGER SIGNS	
<ul style="list-style-type: none"> Operations or situations in which the staff must pay close attention: general danger or dangerous voltage. 	 
<ul style="list-style-type: none"> Low or high temperature zones; Condensation or product leakage which may cause the operator to slip or may injure him/her. 	 
<ul style="list-style-type: none"> Danger due to electromagnetic interference or emission of fumes with a high level of inflammability. Possible danger of explosion. 	 
PROHIBITION SIGNS	
<ul style="list-style-type: none"> Prohibition to access the area examined or prohibition to carry out this operation. 	
CAUTION	
<ul style="list-style-type: none"> Risk of fire 	

SUMMARY

PREAMBLE	1
SYMBOLS AND SIGNS	2
SUMMARY	3
QUICK OPERATION GUIDE	4
FIELD OF EMPLOYMENT	4
INSTALLATION	4
FIRST USE AND KEG REPLACEMENT	5
NOZZLE COLOR MEANING	6
MAINTENANCE	6
SUPPLY CONDITIONS	7
REFERENCE STANDARDS	7
ACCIDENT PREVENTION AND RESIDUAL RISKS	8
LIFTING AND TRANSPORT	9
AIM OF THE DOCUMENT	10
PERSONNEL QUALITIES	10
FIELD OF EMPLOYMENT	10
EQUIPMENT DESCRIPTION	11
MACHINE PARTS	12
TECHNICAL DRAWING CARB_RAFFR	14
IDRAULIC SCHEME	15
ELECTRICAL SCHEME	16
TECHNICAL SPECIFICATION	17
TROUBLESHOOTING	18
NOTES	19
DECLARATION OF CONFORMITY	22

QUICK OPERATION GUIDE

FIELD OF EMPLOYMENT

- **ESCOWA AB** declines any responsibility for damages of any type that arose from non compliant or unwise usage. The machine **MUST NOT** to be operated by inexperienced personnel who operate the unit not in compliance with what is described in the present user's manual and attached documentation.



The machine has been planned to dispense hand sanitizer, with the possibilities and features described in the present book.

Do not use any other kind of liquids or beverage.

Prohibited uses:



- It is strictly forbidden to use the machine or parts of it in flammable environments. The machine can **NOT** be operated or installed in environments with presence of gases or explosive volatile substances.

N.B. **ESCOWA AB** declines any responsibility for unsuitable and/or non-hygienic conditions in the workplace.

- **ESCOWA AB** declines any responsibility for damages of any type that arose from non compliant or unwise usage.
- The use of this equipment or parts of it for other purposes not complying with its proper usage is absolutely forbidden.

INSTALLATION

ATTENTION :

1. **ESCOWA AB** advises the cleaning of the equipment prior to use with a suitable cleaning agent.
2. It is recommended to protect the unit with a ground-fault circuit interrupter

After removing the machine from its packaging, check that the area where the machine is to be installed is solid and perfectly level;

FIRST USE AND KEG REPLACEMENT

Hydraulic connection:

The equipment is supplied hydraulic connection ready.

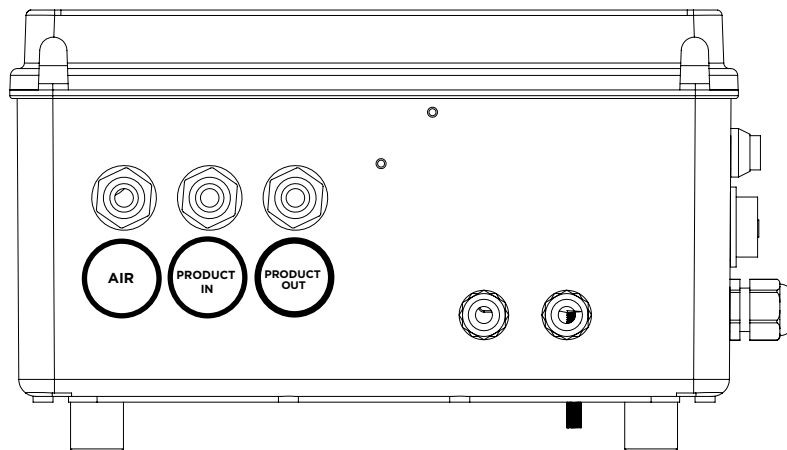

MAINTENANCE

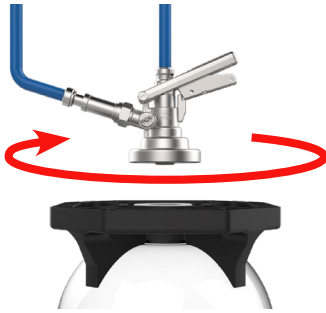

1. Insert the head turning it clockwise on the keg coupling.

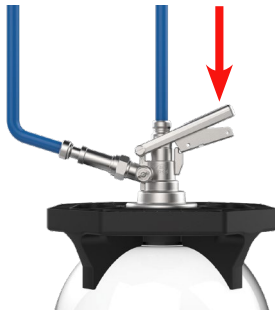

2. Couple the head by pushing down the lever.



3. Turn on the system pushing the green button, the air compressor will start pumping air into the keg, wait until the compressor stop before going in to the next step.



The following step is needed only after the first start up and after each keg replacement

4. Push and hold the red button until the hand sanitizer starts coming out from the nozzle. It is possible that the compressor will turn on again during this operation.



5. It is possible to adjust the amount of hand sanitizer dispensed, by turning the left knob according to the gel density and desired dose. Turn it clockwise to increase it, turn it counter-clockwise to reduce it.

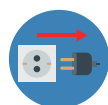

When the keg is empty the user **must release the air from the keg before disconnect the head from it.**

6. Before relasing the air turn off the machine by pressing the green button

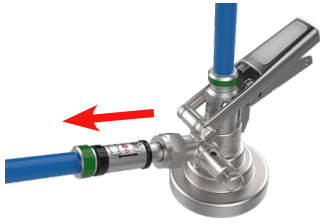

7. Move the release valve as shown in the picture. The air will start to flow out.

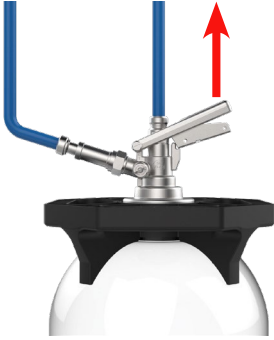

8. Wait until all the air flowed out and then disconnect the head by pulling the lever.

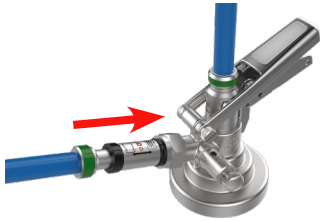

9. Bring the release valve back as shown in the picture before connecting the head to a new keg.

NOZZLE COLORS MEANING



When the nozzle is green the machine is ready to dispense the hand sanitizer. To dispense it simply place the hands under the nozzle. The color will change to blu.



When the nozzle is blu the machine is dispensing the hand sanitizer. Wait until the nozzle will turn back to green before placing again the hands under the nozzle.

Routine maintenance:

Routine maintenance can be carried out by common personnel in compliance with the rules started below.

- Daily: check for leaks.
- Every month clean the machine and vacuum dust, filaments, paper, that may overheat motors or cause faulty operation.

SUPPLY CONDITIONS

ESCOWA AB will not be held liable for any failure to comply with the standards governing correct installation.

ESCOWA AB will not be held liable for any loss in production, unless expressly shown in the purchase order.

ESCOWA AB will not be held liable for any defects or malfunction arising from; improper use of the equipment, alterations due to the transportation or peculiar environmental conditions, lack of or improper maintenance, manhandling or improper service; operation by unqualified personnel and the use of product accessories not belonging to the equipment.

ESCOWA AB will not be held liable for damages arising from inappropriate or imprudent operations not conforming to those described within this manual and in the attached documentation performed by both expert and inexperienced personnel.

Since it is not possible to foresee all the installations and environments in which this equipment will be installed, therefore customer must check the following:

- Environmental conditions where the equipment is installed;
- The capabilities of the personnel entrusted with the installation and/or use of the machine.

The customer must only use original spare parts installed in accordance with their prescribed use.

N.B. Manufacturer accepts liability for commercial parts. If in doubt, ask for documentation.

ESCOWA AB will not be held liable for the disposal of equipment parts or materials needed to operate the machine.

Please remember that this is an electrical equipment and thus its components must be disposed in compliance with the regulations enforced in its country of installation.

List of enclosures

In addition to this operation and maintenance manual the following documents are supplied along with the equipment:

- Declaration of conformity

REFERENCE STANDARDS

This Machine is manufactured in compliance with:

- D.lgs. n° 81(3april2008) 3 august 2009 N° 103.
- D.lgs. n° 89/391, 89/654, 655/CEE, 89/656, 90/269, 90270, 90/394, 90/679, 93/88/CEE, 95/63/CE, 97/42/CE, 98/24/CE 99/38/CE, 99/92/CE, 2001/45/CE, 2003/10/CE, 2003/18/CE e 2004/40/CE
- D.lgs. n° 791, 18 October1977 and D.lsg. (25 November1996) n°626 (2006/95/CE) (September 19th, 1994)
- D.Lgs. n° 194, 6 Novembre 2007 European Community (CEI EN 2004/108/CE) (EMC)
- CEI EN 2006/42/CE Machines
- UNI EN ISO 12100-1 - UNI EN ISO 12100-2 (EMC) Electromagnetic compatibility - CEI E55014-1: CEI E55014-2:
- (EMC) Electromagnetic compatibility

ACCIDENT PREVENTION AND RESIDUAL RISKS

- Although this equipment has been manufactured under the strictest safety regulations, however for obvious reasons it is not possible to foresee all the installations and environments in which this equipment will be installed. Therefore it is pertinent that customer should inform the manufacturer of peculiar installation conditions.
- The instructions set out in this manual do not replace the safety instructions and technical data on installation and operation of the equipment. It neither replaces common sense nor the safety regulations enforced in the country of installation.



- Operators must be given correct information. They must therefore read and follow the technical information set out in the manual and in the attached documentation. Carefully keep the technical documentation accompanying the equipment.
- **ESCOWA AB** will not be held liable if installation instructions are not followed.
- Do not use the equipment if any operating fault occurs.
- The equipment has been designed under strictest energy saving regulations enforced in the manufacturing country therefore customer should avoid unnecessary energy waste.
- The equipment must not be installed outdoors or in adverse environmental conditions (sun,rain,snow,wind,high humidity, etc.) Also make sure that there is no electromagnetic interference.
- Equipment has not been designed to operate in environments in which there is a danger of fire or explosions.
- It is absolutely forbidden to tamper and/or inhibit or modify the safety devices.
- In case of fire, make use of carbon dioxide extinguishers and automatic suction systems to fight against fire in closed environments.



- Cleaning and maintenance operations must be carried out when the machine is off after 5 minutes of unplugging the power cord.



- Personnel must NOT go anywhere near the equipment on bare feet or with wet hands. Personnel must also make use of suitable personal protection device used accordingly. Product leaks may cause slippage.

- Maintenance personnel must report any fault or deterioration due to wear or aging so that safety conditions can be promptly restored.
- Do not carry out makeshift repairs. Only manufacturer-approved spare parts must be used for the repairs and installed accordingly. Components must then be reassembled in the original position and condition.

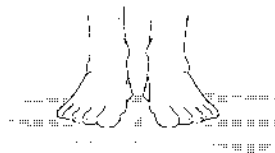
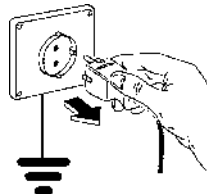

- Cleaning of the equipment should be done with suitable devices and detergents that will not cause it any damage. The use of water jets for equipment cleaning or washing is strictly prohibited. Product circuits must be washed or cleaned with suitable non toxic products.



- The installation, removal and/or reinstallation in other place and extraordinary maintenance operations must be done only by specialized personnel in compliance with the instructions outlined within this manual.
- Proper illumination of equipment installation location is advised in order to guarantee that all necessary operations are carried out in safe conditions.



- Although **ESCOWA AB** has removed sharp edges where possible, however the use of personal protective device e.g. leather gloves is recommended

when handling: sheet metal, self-threading screws, etc...

- The single equipment's output sound level (Noise) when operating at full capacity and correct maintenance is inferior to 70dBA thus absolutely harmless to the operator. Whenever the noise threshold is exceeded due to different and unpredictable installation cases, ask for the intervention of a specialized technician.
- Handling and/or lifting of heavy objects (more than 30Kg) must be carried out by means of suitable lifting devices.

LIFTING AND TRANSPORT

- The equipment is usually shipped in a cardboard box packaging, adequately protected on all its edges. The packaging in its dry and integral state is self-supporting and sturdy enough for machine lifting and handling. If packaging is in a wet state, pay attention while lifting and make sure lifting bands are placed in the centre.
- Stacking of equipment over another is only allowed when packaging is in its integral and dry state.
- Equipment should be lifted one at a time.
- The lifting device (ropes, polyester belts, chains) must be designed to bear the weight of the machines: the opening angle must be the same as or less than 50°-60° in order to avoid crashing or damaging the packaging and/or the bodywork sheet metal.
- During handling, check that the weight of the loads is correctly distributed on the ropes and do not make sudden movements that could create dangerous oscillations.

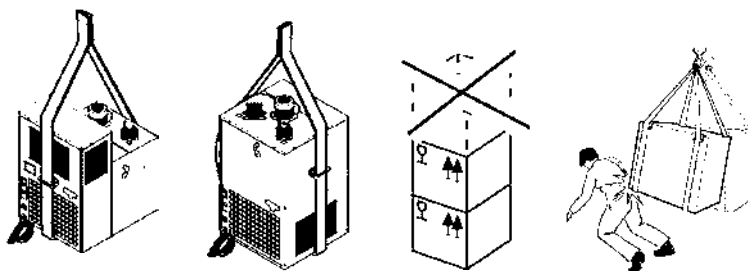

- Remember that packing elements (wood, nails, paper, cellophane, metal points, adhesive tape, straps, cords, etc) may cut and/or cause injury unless they are handled with care. They must be removed with appropriate instruments and must be kept out of the reach of irresponsible persons (e.g. children). These rules also apply to the instruments used in removing the packing (scissors, hammers, pliers, knives, etc). The packing must also be eliminated and disposed of in accordance with the regulations in force in the country of installation



- When opening the packing, check the machine for damage and check that no machine parts or accessories are missing.
- If you detect faults or deterioration, suspend operations immediately and contact the carrier or shipper and also notify.

AIM OF THE DOCUMENT

This document (OPERATION AND MAINTENANCE MANUAL) is a useful guide that enables safe working and the performance of all operations necessary to keep the equipment in a safe working order.



- The instructions set out in this manual do not replace the safety instructions and technical data on installation and operation of the equipment. It neither replaces common sense nor the safety regulations enforced in the country of installation.
- Personnel dealing with the equipment must read this manual carefully; operators must also be made aware of residual risks arising from its use.

PERSONNEL QUALITIES



- Only expert operation or maintenance personnel familiar with the described task and knowledgeable enough to execute them must use this equipment. They must be able to sufficiently carry out the instructions contained in this manual, thoroughly carry out checks and ensure safety.
- The use of unqualified personnel especially for installation and maintenance operations is strictly prohibited.
- Since it is not possible to describe all operational information for the equipment, it is therefore mandatory that persons in operational contact with the equipment possess basic knowledge of its operations in order to perform their duties.
- Personnel in operational contact with the equipment must use the personal protective device required by law: leather gloves for sharpened or pointed objects or components at high temperatures.

FIELD OF EMPLOYMENT

ESCOWA AB will not be held liable for damages of any type arising from non compliant or unwise usage. The equipment **MUST** neither be operated by unqualified personnel nor qualified personnel doing so in non compliance with what is described in the present user's manual and attached documentation.



- The use of this equipment for other purposes rather than those of which it were designed is strictly prohibited.
- This equipment has been designed to dispense hand sanitizer, with the possibilities and features described herein.

Limits of use:

- Allowed room temperature: (+ 10 / + 42 °C) 50°F / 105°F;
- Max. allowable operating pressure: 3,5 bar
- Protection degree IP20 and Insulation Class 1.



Prohibited uses:

- It is strictly prohibited to use the equipment or parts of it in flammable environments. The equipment cannot be operated or installed in environments where gases or explosive volatile substances are present.

N.B **ESCOWA AB** will not be held liable for unsuitable and/or unhygienic conditions in the workplace.

- **ESCOWA AB** will not be held liable for damages of any type arising from non compliant or unwise usage.



This machine, can't be used by people with (children also) poor mental or sensorial skills, or people without enough experience or knowledge, unless these people have been taught about the machine working, unless these people have someone responsible to their safety.

EQUIPMENT DESCRIPTION

The equipment is composed of a compressor, an electrovalve and a keg housed in a metal casing, which protects the live parts.

- **Appropriate uses:**

The equipment is to be used for dispense hands sanitizer through the means of appropriate stainless steel and plastic connections.

- **Inappropriate uses:**

The equipment is not intended for any use other than those specified herein. Do not use the machine for liquids different than hands sanitizer.

Since this equipment has not been designed to operate in the presence of excessive humidity, outdoors and in an explosive atmosphere, therefore the installation and use in such condition is strictly prohibited.

The equipment's main external body is made of sheet metal.

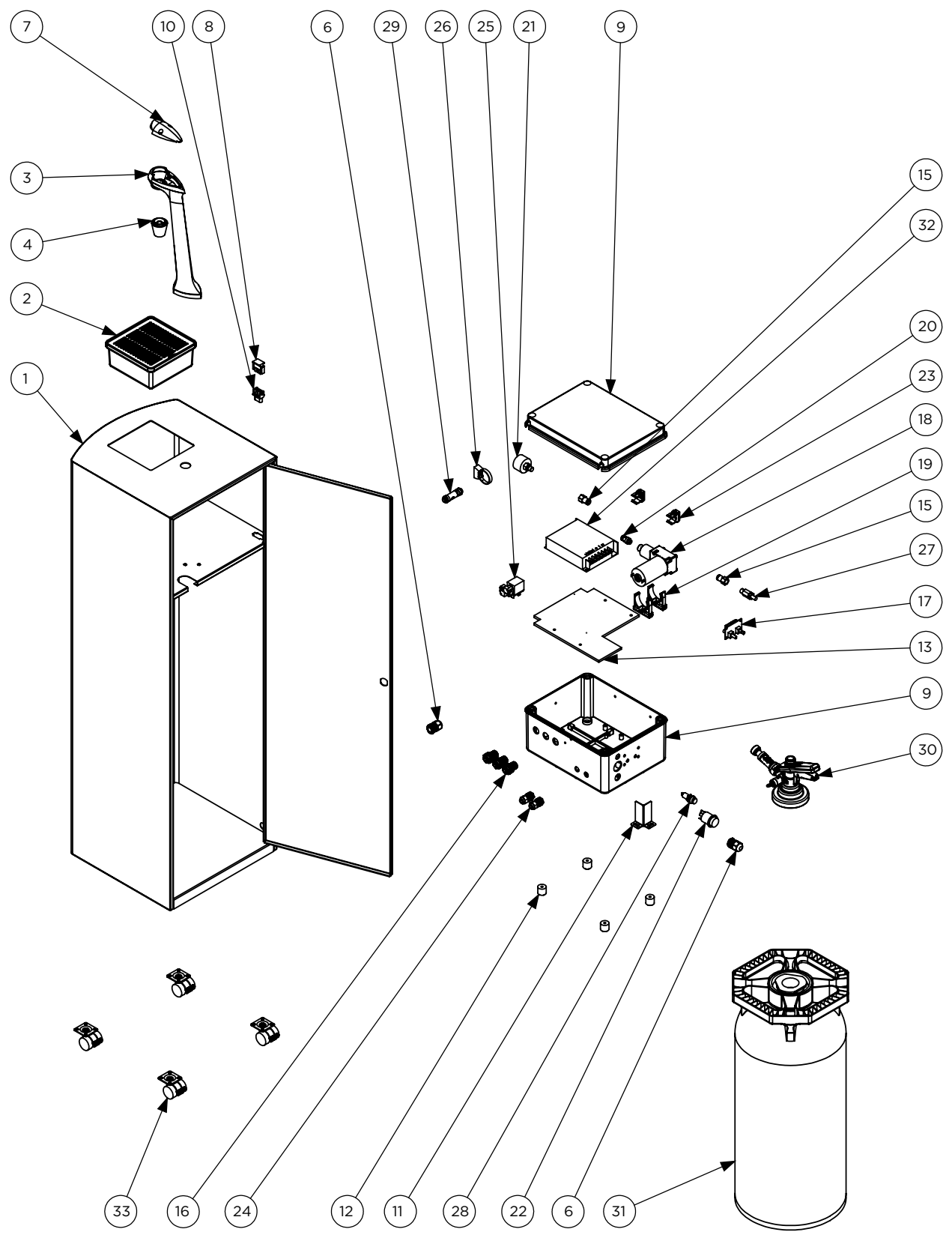

N°	DESCRIPTION	QTY	N°	DESCRIPTION	QTY
1	HSS LOCKER WHITE PAINTED	1	18	AIR COMPRES. 12V CS12V18	1
2	LID+GRID DRIPTRAY CLAMP	2	19	SNAP CLIP TUBE HOLDING D.40	2
3	HSS COL. CHROME PIERCED FOR IR	1	20	STRAIGHT FITTING 1/8 MALE D6	1
4	NOZZLE DISPENSE HSS POLIC OPAL	1	21	3 BAR PRESSURE SWITCH CEME	1
5	Screw ISO 7045-M4 X	2	22	PUSH BUTTON X BOTTE	1
6	CABLE GLAND GEWISS PG9	2	23	SNAP CLIP TUBE HOLDING D.16	2
7	CHROMED W5 NITTOKU COL. TOP	1	24	CABLE GLAND SCAME D.7	2
8	PLUG AMP 3 POS. MALE	1	25	ELECTROVALVE 12V DC 6mm QUICK MOUNT	1
9	WATERTIGHT BOX 240X190X130 HOL	1	26	16-32 INSET PLASTIC ZIP TIE	1
10	SOCKET 3P. FEMALE	1	27	SAFETY VALVE 3 BAR 1/8 THREAD	1
11	GEWISS BOX FIXING BRACKET HSS	1	28	PUSH BUTTON ON 2 CONTACT	1
12	FEET RUBBER SPRING	4	29	NON-RETURN VALVE JG 6mm	1
13	HSS COMP. FIXING BOARD FOREX	1	30	KEY KEG TAP HEAD 5/8-5/8 DSI	1
14	ANTIVIBR. SPACER 2XM5_MALE.D20	2	31	KEY KEG	1
15	FITTING 1/8G F. - 6mm	2	32	POWER SUP. 220-12V 100VA 8,5Ah	1
16	6MM FITTING PM1206E	3	33	BLACK ABS WHEEL H30 mm 4 SCREW	4
17	EV + LED CONTROL TIMER BOARD	1			

TECHNICAL DRAWING
measures in mm

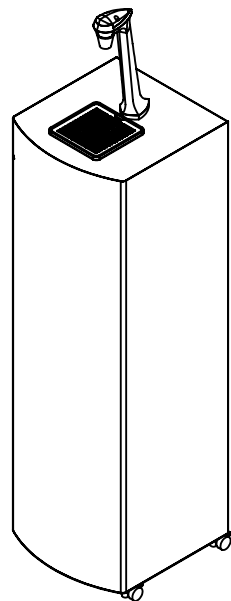
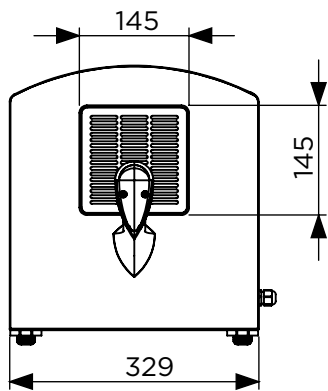
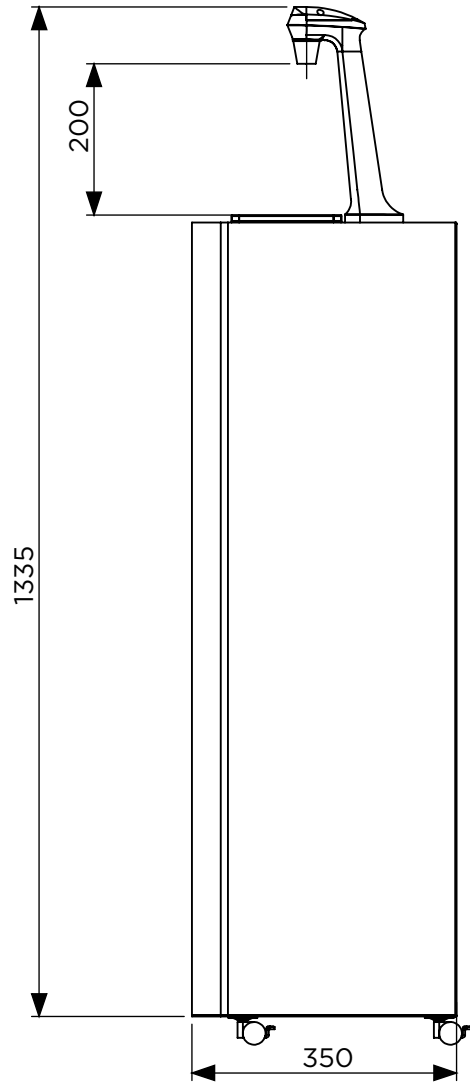
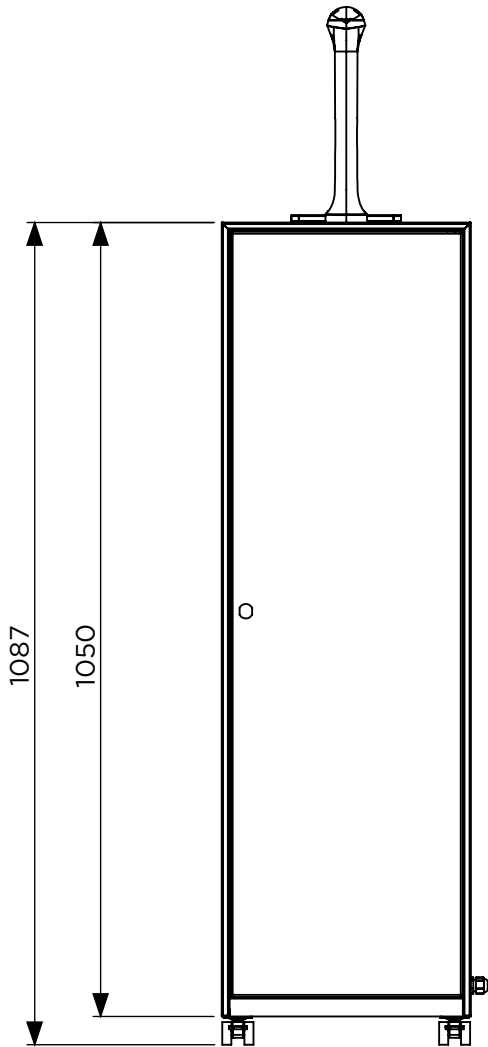

IDRAULIC SCHEME

C	COMPRESSOR	K	KEG
PS	PRESSURE SWITCH	E	ELECTROVALVE
PR	PRESSURE RELIEF VALVE	D	DISPENSER

 AIR

 GEL

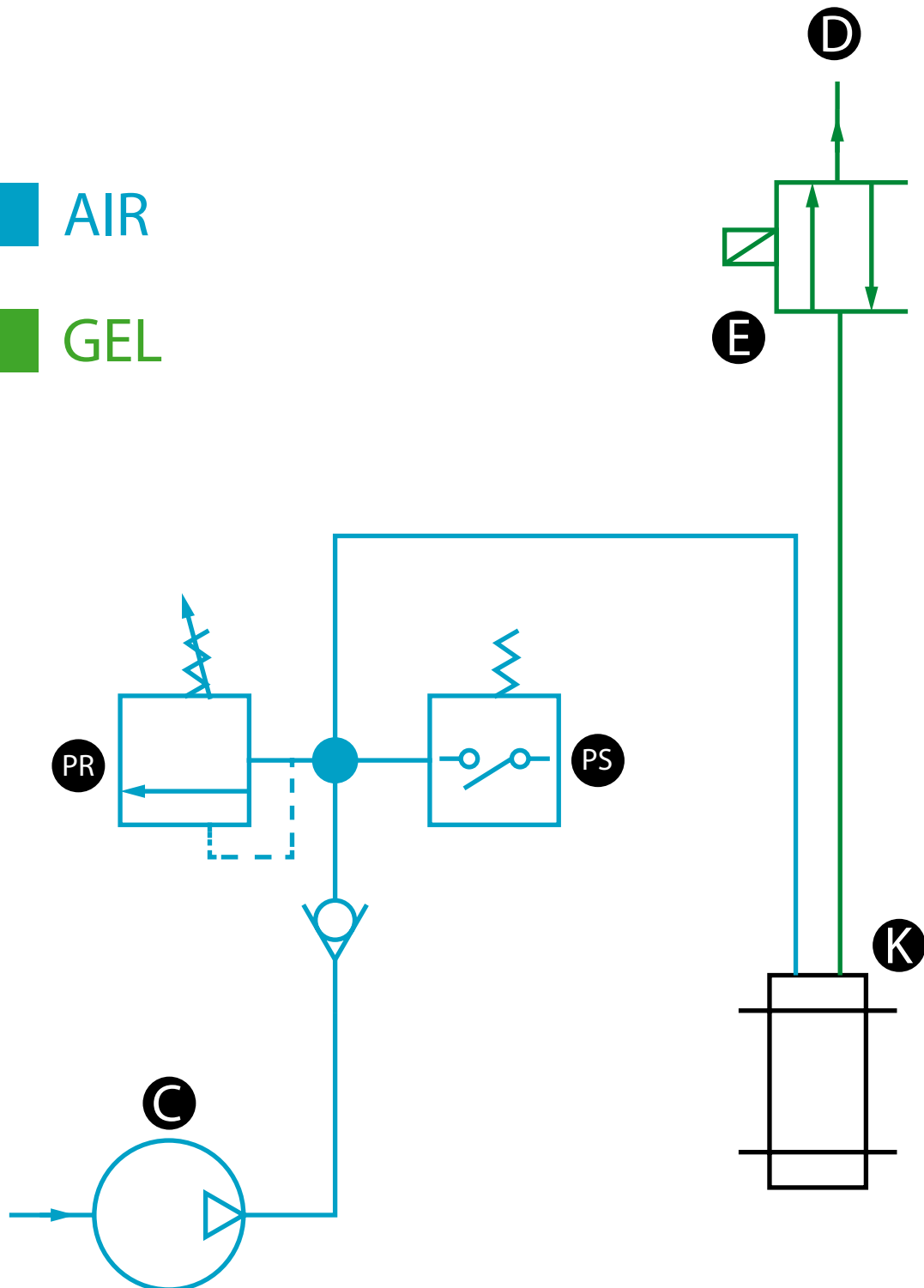

ELECTRICAL SCHEME

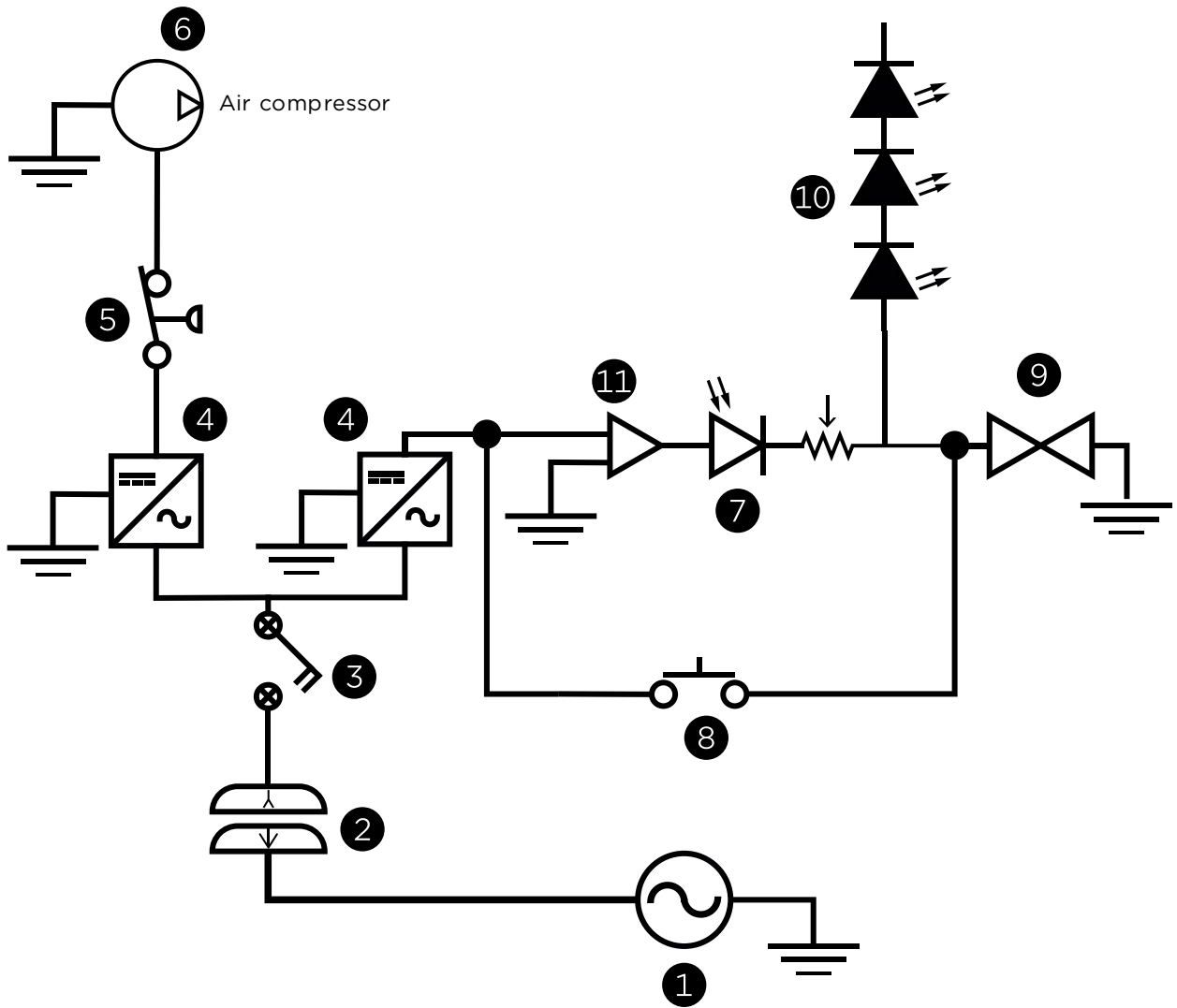

LEGEND			
1	PLUG	7	MOVEMENT SENSOR
2	CONNECTION	8	CIRCUIT FILLING BUTTON
3	ILLUMINATED BIPOLAR SWITCH	9	ELECTROVALVE
4	CONVERTER	10	RGB LED STRIP
5	PRESSURE SWITCH	11	MICROCONTROLLER
6	AIR COMPRESSOR		

TECHNICAL SPECIFICATIONS



	OPTISAN	
VOLTAGE	220V 50 Hz	220V 50 Hz
KEG CAPACITY	20 lt	5,3 gal
COMPRESSOR	24 W 3 BAR	24 W 3 BAR
NET WEIGHT	22,5 Kg (without keg)	49,6 lb
HOUSING	Painted steel	Painted steel

TROUBLESHOOTING

ANOMALIES FOUND	POSSIBLE CAUSES	CHECKS AND REMEDIES
The machine does not work	Missing electric power supply	Check the power mains Check that the plug is inserted in the socket outlet
Machine is ON but gel is not dispensed	Lack of voltage to parts Pump doesn't work Electronic board failure Probe failure Keg is empty	Check and in case: replace air compressor Check internal wiring Replace electronic board Replace IR sensor Replace keg



N.B. Control and maintenance operations must be carried out when the machine is stationary and with the power supply disconnected, pulling out the plug. Any operation excluded from those stated below must be carried out by specialized and authorized personnel.

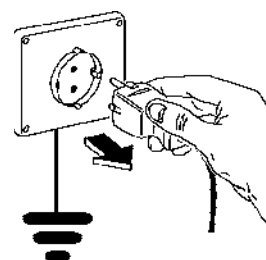



ESCOWA AB T: 08-557 731 00
Moränvägen 9 F: 08-557 731 28
186 40 Vallentuna www.escowa.se

Declaration of Conformity

DECLARES UNDER THEIR OWN RESPONSIBILITY THAT THE BELOW MACHINE
HAS BEEN BUILT AND DESIGNED IN ACCORDANCE WITH THE SAFETY
REQUIREMENTS PROVIDED FOR BY "CE" MARKING STANDARDS

Model

OPTISAN

In accordance with directives

Directive No	Reference
2006/42/EG	MACHINE
2006/95/EG	LOW TENSION
2004/108/EG	EMC

Responsible for technical documentation

Fredrik Friberg, Technical Manager
Escowa AB, Vallentuna

Vallentuna, 2020-08-15
Mattias Källemyr, CEO

